

Performance Spectrum

Heart of Hightech



**Gear Pumps for
Plant and Process Engineering,
Chemical and Petrochemical**



Gear Pumps as universal Dosing and Process Pumps

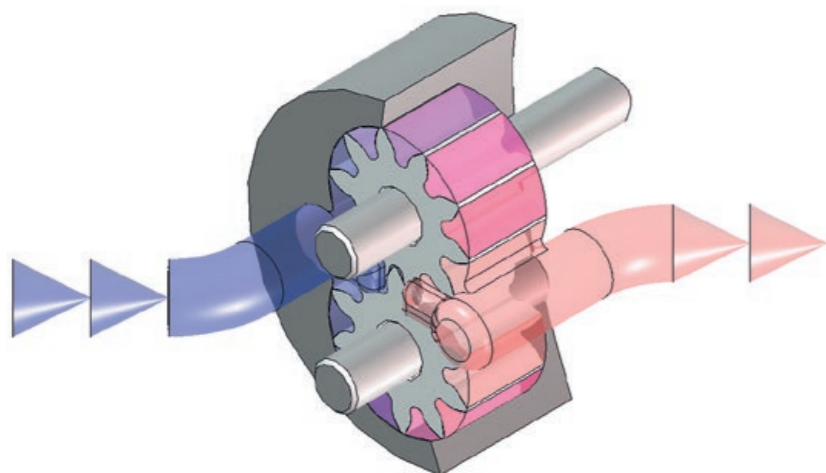

Functional Principle

Gear pumps belong to the group of rotating displacement pumps. They pump fluids by means of two intermeshing rotors. A distinction is made between external and internal gear pumps, depending on the gear teeth design. The rotor fitted on the driven shaft of the gear pump transfers the rotary movement to the second rotor. A fluid volume proportional to the speed is displaced by the rotation. This allows fluids to be extracted and pumped even against high pressures.

As a specialist for rotating displacement pumps, Scherzinger has focused solely on all-purpose external gear pumps with regard to the described pumps. Due to the low inner friction values, this pump principle is very energy-efficient and the pump is subject to a low degree of wear.

Structural Design

To ensure absolute leakproofness, the pump is driven and at the same time also sealed by means of a magnetic coupling.

The driving torque is transferred to the drive shaft on the pump side by permanent magnets to the drive shaft on the pump side through a non-magnetic, cup-shaped partition wall.

We have paid particular attention to preventing sealing points also in the design of the pump body, which consists of only two pieces. As a result, the pump is sealed only statically with o-rings. This qualifies the pump specifically for use with toxic, curing or aggressive fluids.

The shafts with gears fitted on them are installed on both sides of the housing and cover with pressed-in sleeve bushings in order to absorb high bearing loads. The gears and sleeve bushings have been optimized for a wide range of applications with fluids of very low to very high viscosity to prevent noise and pulsation.



Applications and Range of Use

Scherzinger Chemical Series Gear Pumps are suitable for virtually all fluid media from bases to different acids.

The Pumps can be used:

- For low to medium viscous and particle-free liquids
- For everything from degreasing agents through to strong lubricants
- For alkaline and acidic fluid media
- For inlet pressures of 80 mbar absolute through to 100 bar positive pressure
- For speeds of 0 up to 6,000 RPM
- For use in normal and hazardous environments (ATEX II 2G & II 2D)

Sample applications include:

- **Biotechnology:** Handling of fluids in the fermentation process
- **Petrochemistry:** Transfer of sulphuric acid during the production of bio-diesel
- **Chemistry:** Feed and discharge out of vaporizers and reactors
- **Laboratory:** Metering a wide range of fluid with replaceable pump head
- **Pharmaceuticals:** Coating of syringe bodies
- **Process Engineering:** Circulation of flush fluids in rotating mechanical seal systems

Frequently Handled Fluids

- Caustic Soda
- Sulphuric Acid
- White Oils
- Soldering Flux
- Methanol
- De-Ionised water
- Glycerine, Glycols
- Di-Isocyanate
- Flocculent
- Inks
- Emollients
- Hydrogen Peroxide
- Lubricants
- Polyols, Polymers
- Adhesives
- Paraffin Oils

Gear Pumps as universal Dosing and Process Pumps

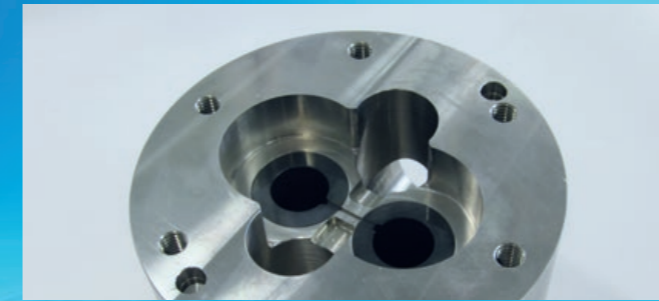

Implementable Flow Rates

The flow rate of a Gear Pump is virtually proportional to its speed.

The following table shows the possible flow rates of the respective pump sizes.

The dimensions are based on media viscosity of 1 mPas and depressurized pumping.

Pump	(cc/rev)	Rotation speed (RPM)							
		690	830	950	1150	1450	1725	2830	3360
2030-009	0.09	0.062	0.075	0.086	0.104	0.131	0.155	0.255	0.302
2030-016	0.16	0.110	0.133	0.152	0.184	0.232	0.276	0.453	0.538
2030-026	0.26	0.179	0.216	0.247	0.299	0.377	0.499	0.736	0.874
3030-045	0.45	0.31	0.37	0.43	0.52	0.65	0.78	1.27	1.51
3030-070	0.7	0.48	0.58	0.67	0.81	1.02	1.21	1.98	2.35
3030-110	1.1	0.76	0.91	1.05	1.27	1.60	1.90	3.11	3.70
4030-280	2.8	1.93	2.32	2.66	3.2	4.1	4.8	7.9	9.4
4030-450	4.5	3.11	3.74	4.28	5.2	6.5	7.8	12.7	15.1
4030-710	7.1	4.90	5.89	6.75	8.2	10.3	12.2	20.1	
5030-130	13	9.0	10.9	12.4	15.0	18.9	22.4	36.8	
5030-210	21	14.5	17.4	20.0	24.2	30.5	36.2	59.4	
5030-350	35	24.2	29.0	33.3	40.3	50.8	60.4		

The selected speeds correspond to the available nominal speeds of standardized industrial motors in 50 and 60 Hz operation mode.

If the differential pressure is increased or the viscosity reduced, the actual flow rate drops due to the gap losses. Please also observe that the maximum possible differential

pressure drops at lower viscosity. At higher viscosity, the pump speed must be reduced to avoid cavitation.

Application Limits

	Standard Program	Custom Applications
Temperature Range	-20 ° to 130 °C	-40 ° to 250 °C
Differential Pressure	10 bar	40 bar
Inlet Pressure	-0.9 to 100 bar	-0.95 to 250 bar
Viscosity Range	0.5 to 6,000 mPas	0.3 to 50,000 mPas

Materials

Pump		2030	2040	2050	3030	3040	3050	4030	4040	4050	5030	5040	5050
Case and Shafts	SS 316 L, SS 316 Ti	■			■			■			■		
	Hastelloy C4		■			■			■			■	
	Titanium Grade 7			■			■			■			■
Gears	PEEK mod.	■	■	■	■	■	■	■	■	■	■	■	■
	PTFE mod.		■	■		■	■		■	■		■	■
	PPS mod.	■	■	■	■	■	■	■	■	■	■	■	■
	SS hardened				■			■			■		
	Waukesha 88					■			■			■	
	Nitronic 60				■			■			■		
	Carbon	■	■	■	■	■	■	■	■	■	■	■	■
Bearings	PEEK mod.	■	■	■	■	■	■	■	■	■	■	■	■
	PTFE mod.		■	■		■	■		■	■		■	■
	PPS mod.	■	■	■	■	■	■	■	■	■	■	■	■
	SSiC / Cr ₂ O ₃				■	■	■	■	■	■	■	■	■
	SSiC / Al ₂ O ₃				■	■	■	■	■	■	■	■	■
	Carbon	■	■	■	■	■	■	■	■	■	■	■	■
Seals	PTFE	■	■	■	■	■	■	■	■	■	■	■	■
	Buna N	■	■	■	■	■	■	■	■	■	■	■	■
	FKM	■	■	■	■	■	■	■	■	■	■	■	■
	FFKM	■	■	■	■	■	■	■	■	■	■	■	■
	EPDM	■	■	■	■	■	■	■	■	■	■	■	■
	CR	■	■	■	■	■	■	■	■	■	■	■	■

Gear pumps of this series can be configured in very different materials.

This allows the pumps to be adapted to your application at all times. As a result, a wide range of materials are available depending on their

corrosion resistance, temperature range and the required differential pressure.

■ Standard program
■ Optional materials

Dosing and Process Pumps



up to 1.6 l/min

Pump Specifications

for the material combination stainless steel with PEEK, PPS or PTFE gears and bearings

	2030-009	2030-016	2030-026
Displacement	0.09 ml/rev	0.16 ml/rev	0.26 ml/rev
Max. Rotation speed	6,000 RPM	6,000 RPM	6,000 RPM
Max. Discharge 1450 1/min	130 ml/min	210 ml/min	390 ml/min
Max. Discharge 2830 1/min	250 ml/min	420 ml/min	760 ml/min
Max. Discharge 6000 1/min	540 ml/min	900 ml/min	1620 ml/min
Max. Differential pressure	10 bar	10 bar	10 bar
Max. Inlet pressure	100 bar	100 bar	100 bar
Max. Suction negative pressure absolut	250 mbar	250 mbar	250 mbar
Temperature range PEEK & PPS	-20 ° to 130 °C	-20 ° to 130 °C	-20 ° to 130 °C
Viscosity range	5 to 3,000 mPas	5 to 3,000 mPas	5 to 3,000 mPas
Direction of Rotation	optional	optional	optional
Connections	G 1/8 ", NPT 1/8 "	G 1/8 ", NPT 1/8 "	G 1/8 ", NPT 1/8 "
By-pass relief valve	available	available	available
Pressure control valve	not available	not available	not available
Max. Transmitted torque of the mag drive	250 mNm	250 mNm	250 mNm

Exemplary dimensions

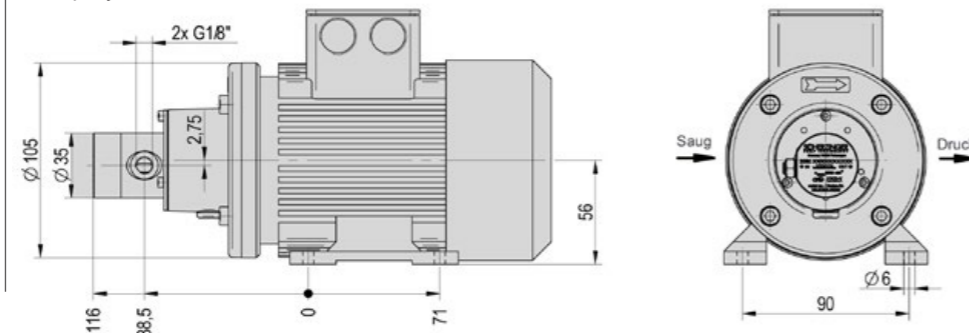

Performance curves of pump size 2030-009

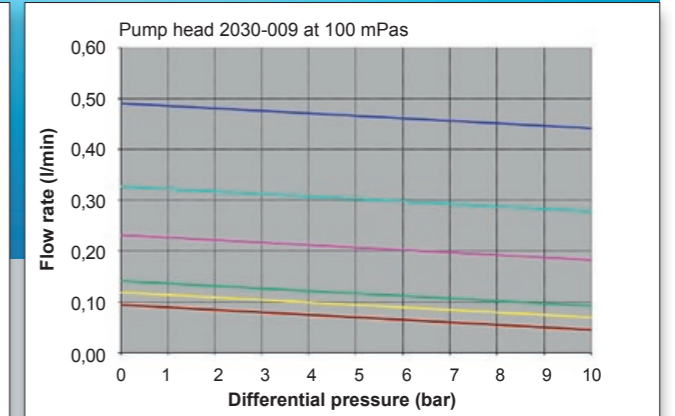
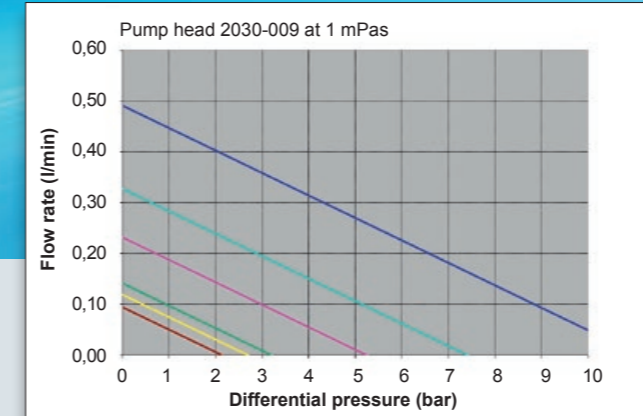

Performance curves of pump size 2030-016

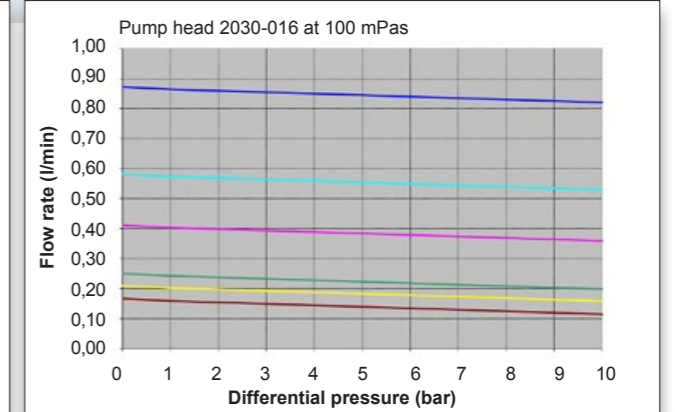
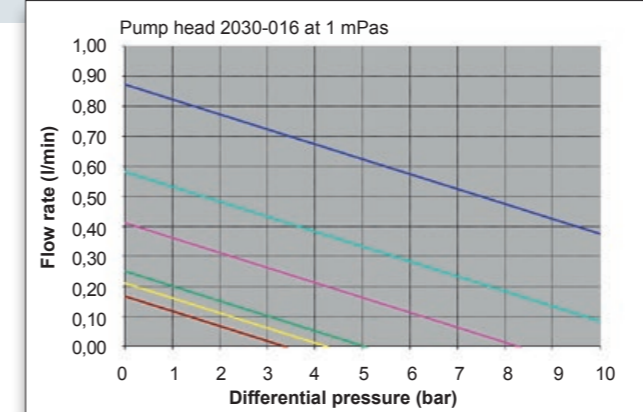

Performance curves of pump size 2030-026

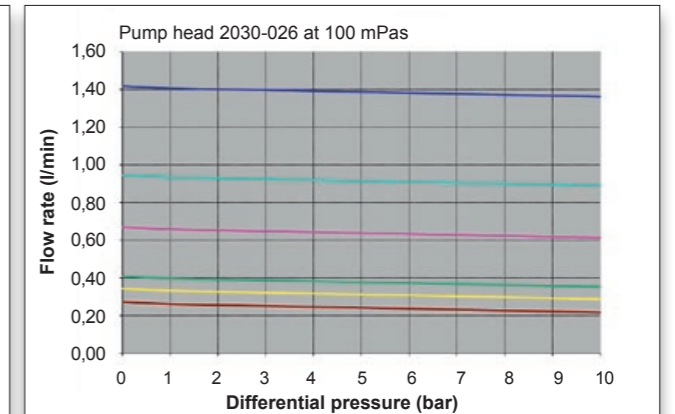
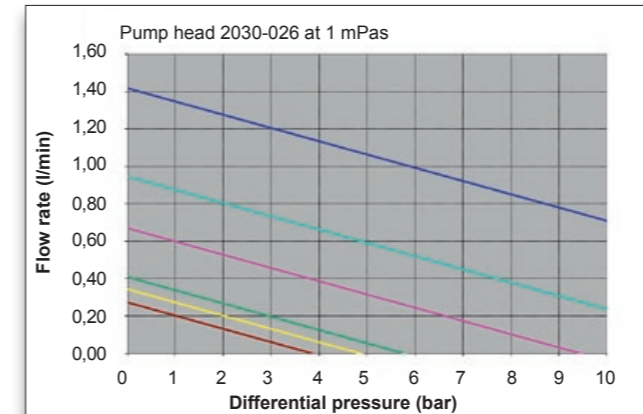

■ 6000 RPM | ■ 4000 RPM | ■ 2830 RPM | ■ 1725 RPM | ■ 1450 RPM | ■ 1150 RPM

Dosing and Process Pumps

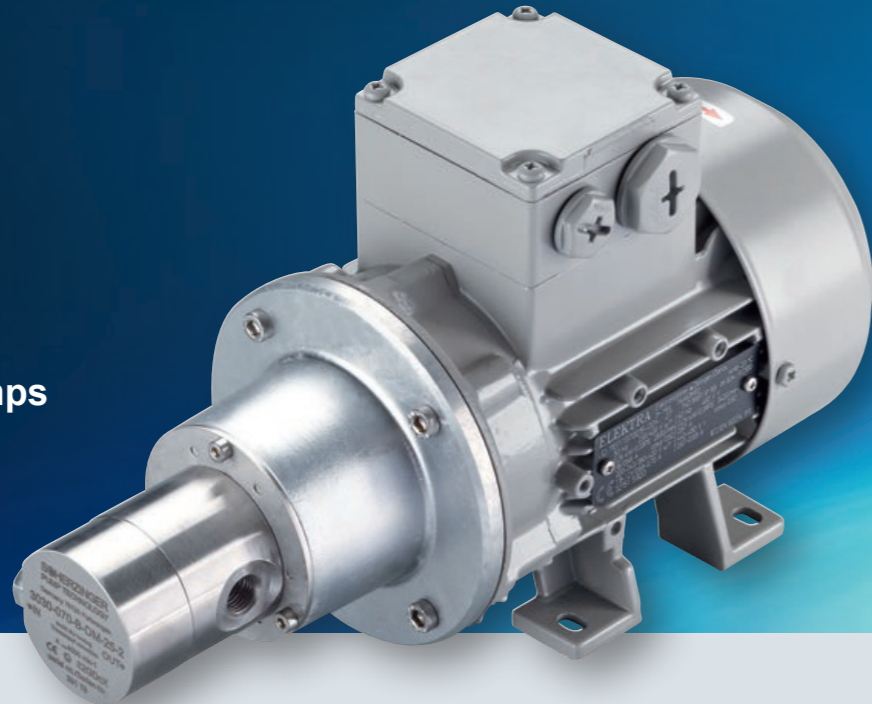

up to 4.4 l/min

Pump Specifications

for the material combination stainless steel with PEEK, PPS or PTFE gears and bearings

	3030-045	3030-070	3030-110
Displacement	0.45 ml/rev	0.7 ml/rev	1.10 ml/rev
Max. Rotation Speed	4,000 RPM	4,000 RPM	4,000 RPM
Max. Discharge 1450 1/min	0.65 l/min	1.05 l/min	1.59 l/min
Max. Discharge 2830 1/min	1.27 l/min	1.98 l/min	3.11 l/min
Max. Discharge 4000 1/min	1.8 l/min	2.8 l/min	4.4 l/min
Max. Differential pressure	10 bar	10 bar	10 bar
Max. Inlet pressure	100 bar	100 bar	100 bar
Max. Suction negative pressure absolute	150 mbar	150 mbar	150 mbar
Temperature range PEEK & PPS	-20 ° to 130 °C	-20 ° to 130 °C	-20 ° to 130 °C
Temperature range PTFE	-20 ° to 70 °C	-20 ° to 70 °C	-20 ° to 70 °C
Viscosity range	0.5 to 3,000 mPas	0.5 to 3,000 mPas	0.5 to 3,000 mPas
Direction of rotation	optional	optional	optional
Connections	G 1/4 ", NPT 3/8 "	G 1/4 ", NPT 3/8 "	G 1/4 ", NPT 3/8 "
By-pass relief valve	available	available	available
Pressure control valve	available	available	available
Max. Transmitted torque of the mag drive	650 mNm	650 mNm	650 mNm

Exemplary dimensions

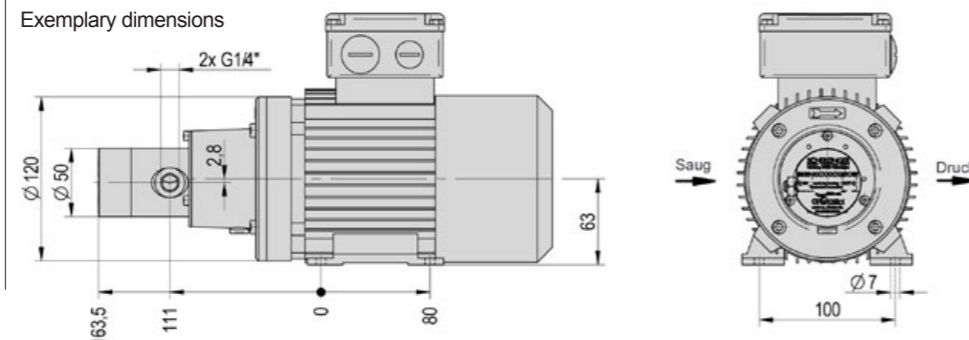

Performance curves of pump size 3030-045

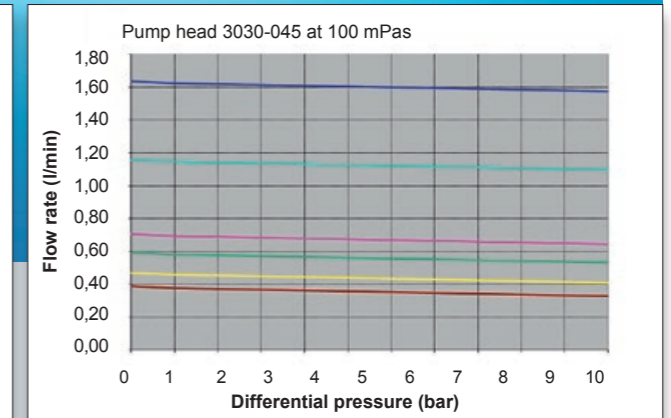
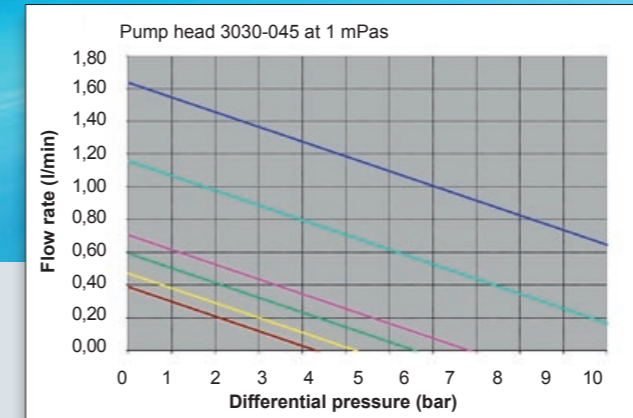

Performance curves of pump size 3030-070

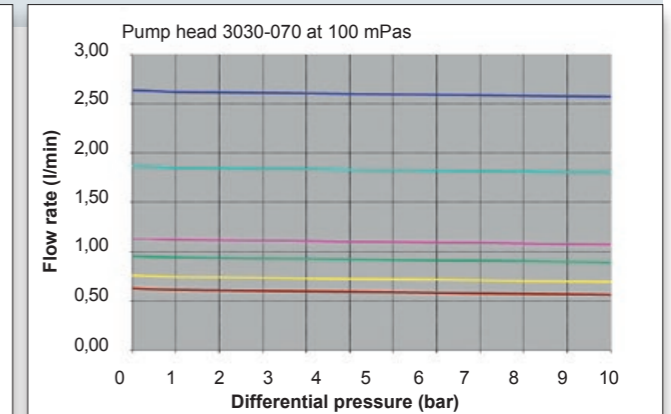
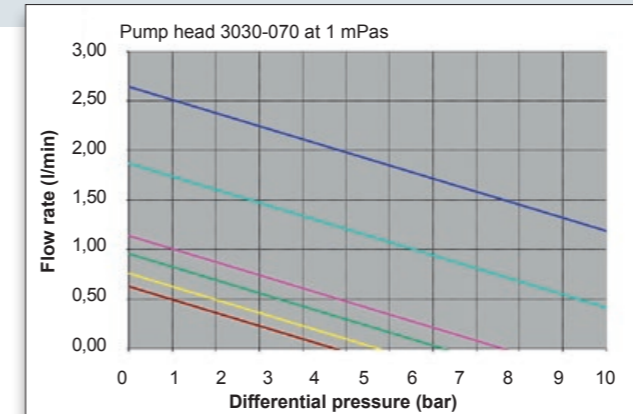

Performance curves of pump size 3030-110

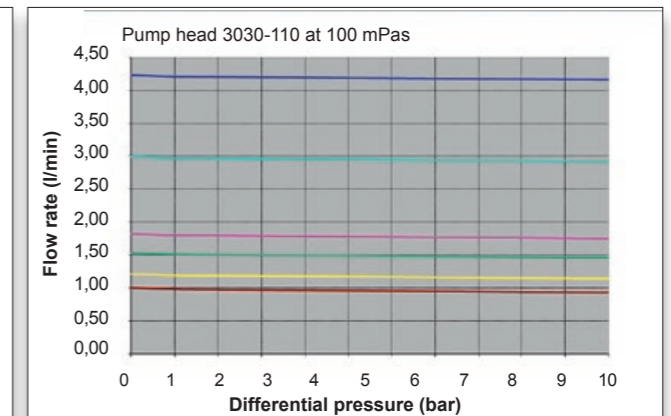
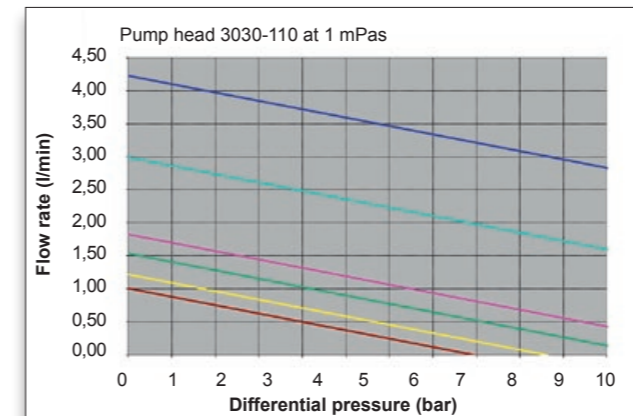

■ 4000 RPM | ■ 2830 RPM | ■ 1725 RPM | ■ 1450 RPM | ■ 1150 RPM | ■ 950 RPM

Dosing and Process Pumps



up to 20 l/min

Pump Specifications

for the material combination stainless steel with PEEK, PPS or PTFE gears and bearings

	4030-280	4030-450	4030-710
Displacement	2.8 ml/rev	4.5 ml/rev	7.1 ml/rev
Max. Rotation Speed	3500 RPM	3500 RPM	3,000 RPM
Max. Discharge 1450 1/min	4.06 l/min	6.52 l/min	10.30 l/min
Max. Discharge 2830 1/min	7.92 l/min	12.73 l/min	20.05 l/min
Max. Discharge 3500 1/min	9.80 l/min	15.75 l/min	–
Max. Differential pressure	12 bar	12 bar	12 bar
Max. Inlet pressure	100 bar	100 bar	100 bar
Max. Suction negative pressure absolute	80 mbar	80 mbar	80 mbar
Temperature range PEEK & PPS	-20 ° to 130 °C	-20 ° to 130 °C	-20 ° to 130 °C
Temperature range PTFE	-20 ° to 70 °C	-20 ° to 70 °C	-20 ° to 70 °C
Viscosity range	0.5 to 5,000 mPas	0.5 to 5,000 mPas	0.5 to 5,000 mPas
Direction of rotation	optional	optional	optional
Connections	G 1/2 ", NPT 3/4 "	G 1/2 ", NPT 3/4 "	G 3/4 ", NPT 1 "
By-pass relief valve	available	available	available
Pressure control valve	available	available	available
Max. Transmitted torque fo the mag drive	2 Nm	2 Nm	4 Nm

Exemplary dimensions

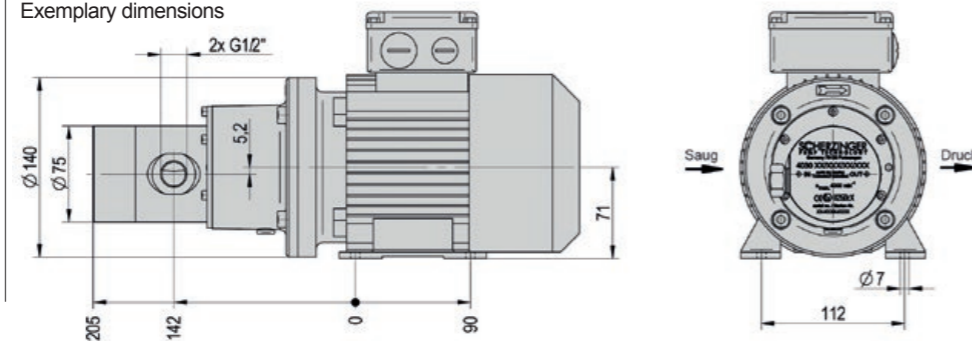

Performance curves of pump size 4030-280

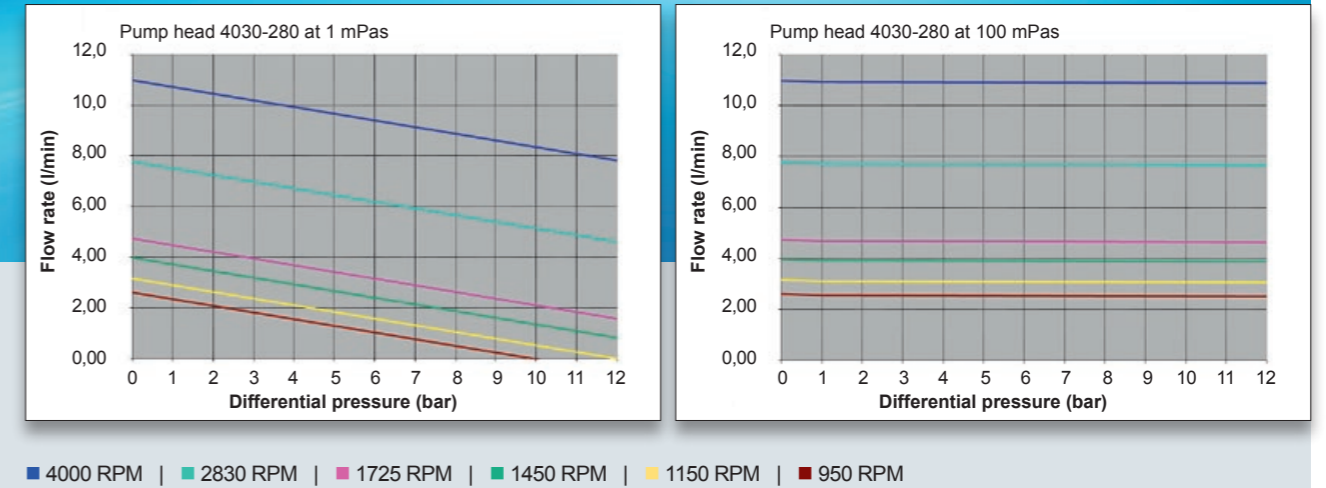

Performance curves of pump size 4030-450

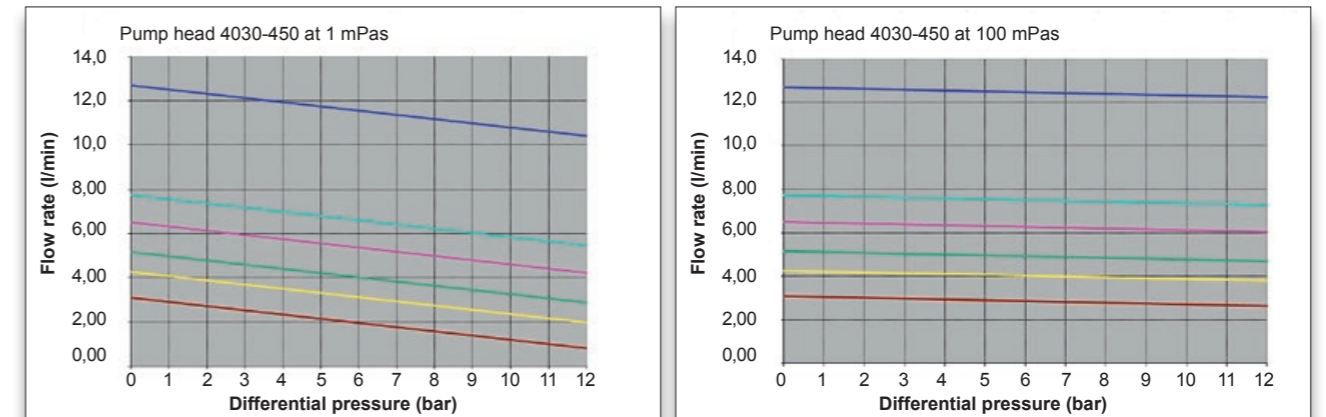

Performance curves of pump size 4030-710

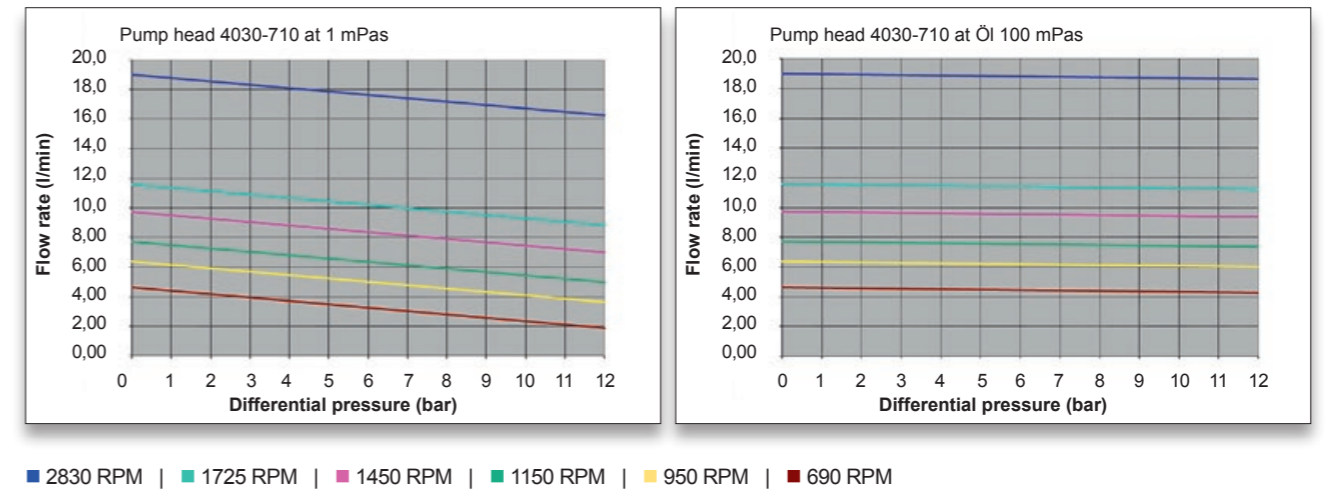

Dosing and Process Pumps

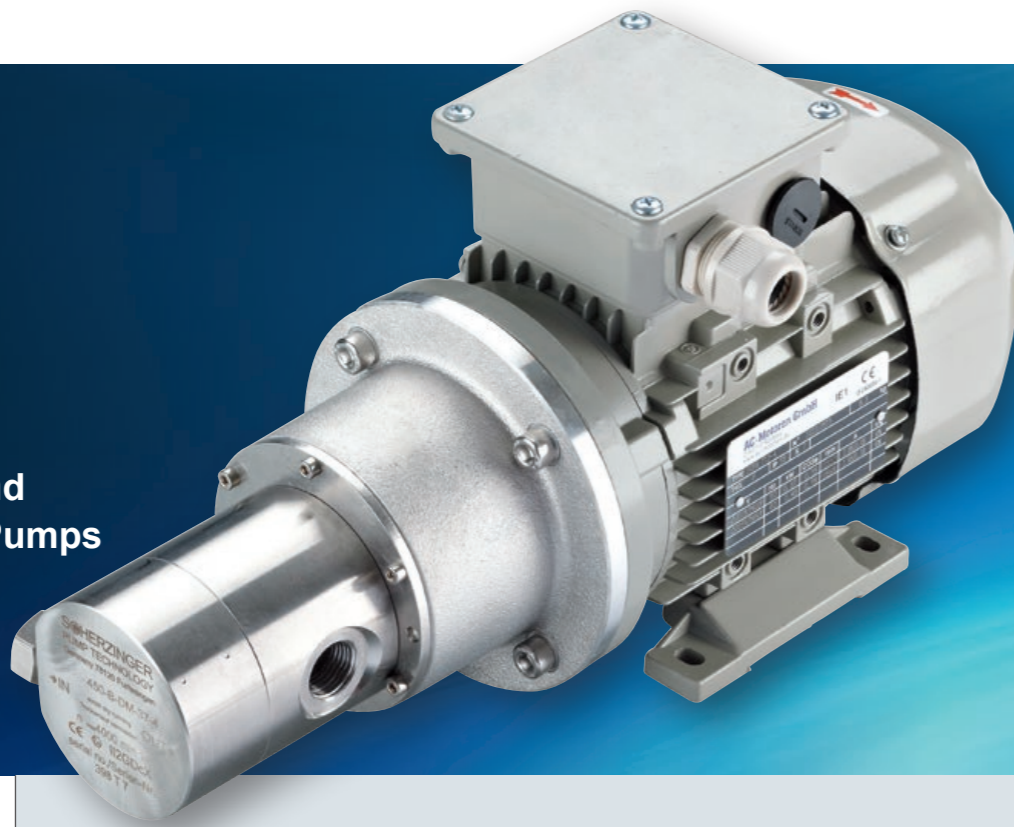

up to 90 l/min

Pump Specifications

for the material combination stainless steel with PEEK, PPS or PTFE gears and bearings

	5030-130	5030-210	5030-350
Displacement	13 ml/rev	21 ml/rev	35 ml/rev
Max. Rotation speed	3,000 RPM	2,800 RPM	2,600 RPM
Max. Discharge 1450 1/min	18.8 l/min	30.4 l/min	50.7 l/min
Max. Discharge 2830 1/min	36.7 l/min	59.4 l/min	—
Max. Discharge 3000 1/min	39.0 l/min	—	—
Max. Differential pressure	12 bar	12 bar	12 bar
Max. Inlet pressure	100 bar	100 bar	100 bar
Max. Suction negative pressure absolute	80 mbar	80 mbar	80 mbar
Temperature range PEEK & PPS	-20 ° to 130 °C	-20 ° to 130 °C	-20 ° to 130 °C
Temperature range PTFE	-20 ° to 70 °C	-20 ° to 70 °C	-20 ° to 70 °C
Viscosity range	0.5 to 6,000 mPas	0.5 to 6,000 mPas	0.5 to 6,000 mPas
Direction of rotation	optional	optional	optional
Connections	G 1 ", NPT 1 1/4 "	G 1/2 ", NPT 1 1/4 "	G 1 1/2 ", NPT 1 1/2 "
By-pass relief valve	available	available	available
Pressure control valve	available	available	available
Max. Transmitted torque of the mag drive	15 Nm	15 Nm	15 Nm

Exemplary dimensions

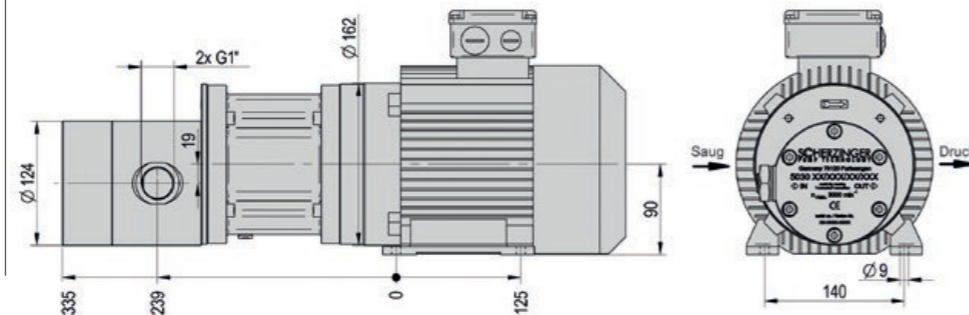

Performance curves of pump size 5030-130

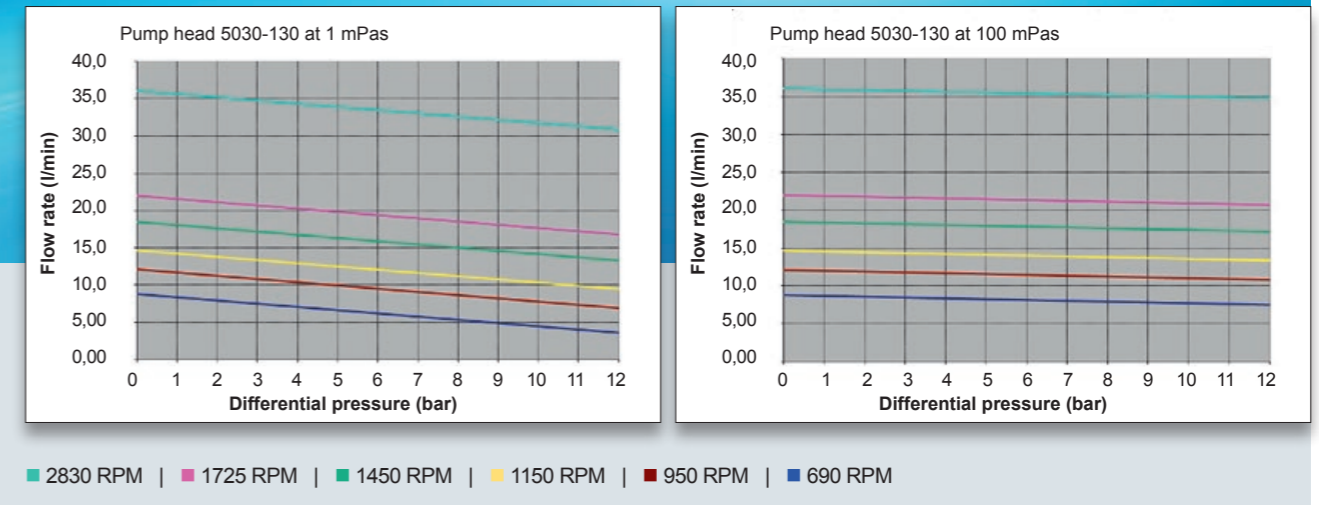

Performance curves of pump size 5030-210

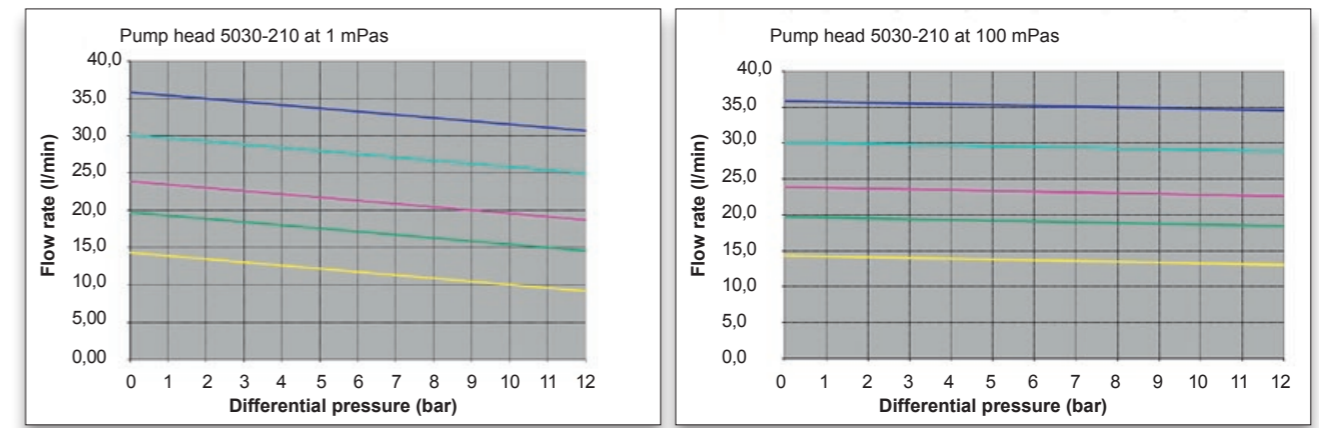

Performance curves of pump size 5030-350

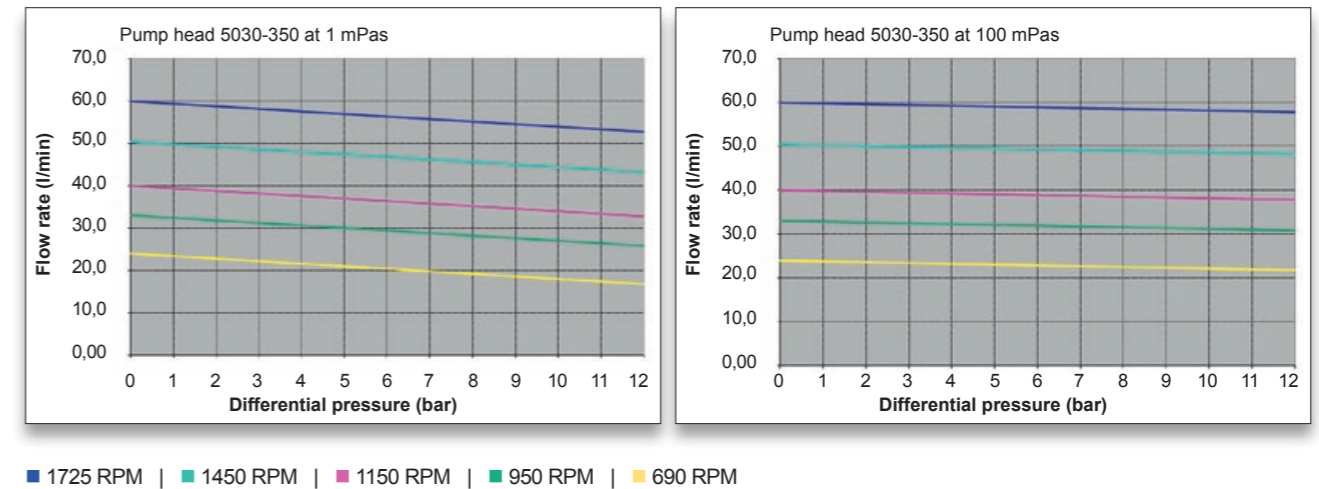

Drives and applications in potentially explosive areas

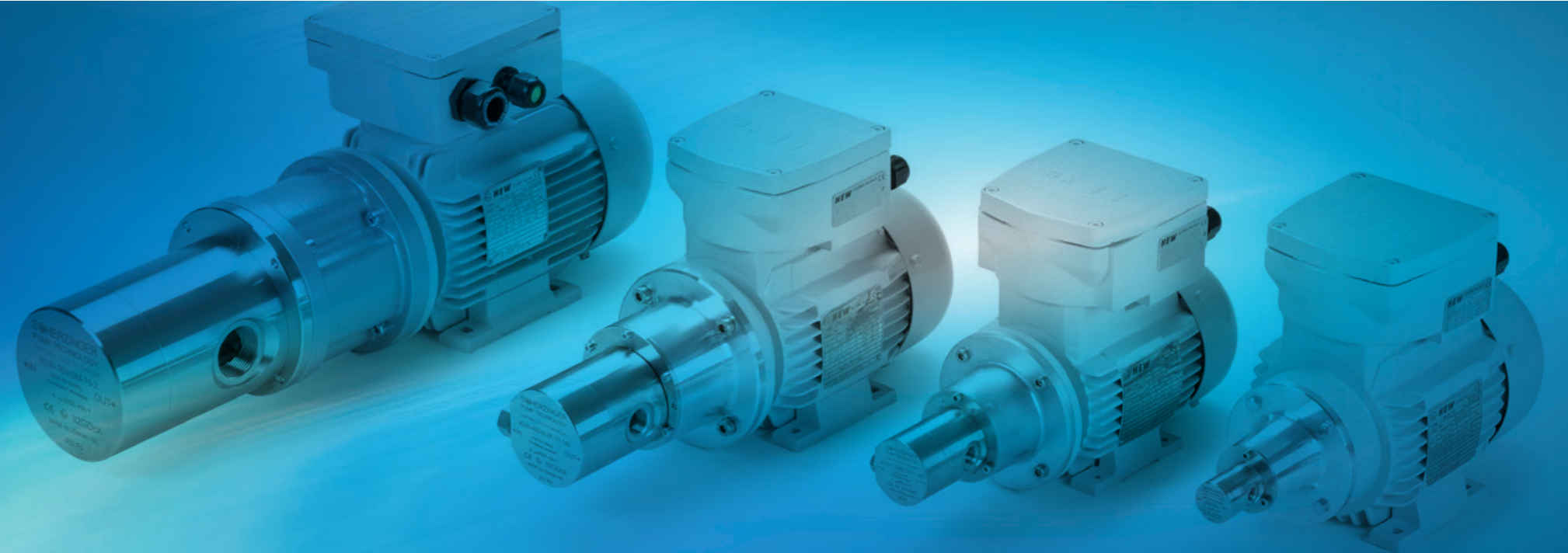

Application in potentially explosive areas

The gear pumps are designed in such a manner that almost all versions comply with the standard ATEX 94/9/EC and can be used in potentially explosive areas.

Additional equipment may be necessary, depending on the pump size and the application conditions. The following overview shows all available options.

	II 2G Zone 1 Zone 2	II 2D Zone 21 Zone 22	Integrated valve possible	Temperature sensor in cover avail.	Temperature sensor mag. coupling avail.
2030	■	■	■		
3030	■	■	■	■	
4030-280	■	■	■	■	■
4030-450	■	■		■	■
4030-710	■	■		■	■
5030-130	■	■		■	■
5030-210	■	■		■	■
5030-350	■	■		■	■

Pump Drives

Our gear pumps are prepared for installation on industrial squirrel-cage motors in compliance with the IEC standard.

The following table shows the combination options of the various pump and motor sizes.

The following drive variants are therefore possible with these motor sizes:

- Any connection voltages at 50 Hz or 60 Hz line frequency
- Fixed speed or pole-changing motors
- Increased safety or flameproof enclosure for potentially explosive areas

- Temperature sensors in the winding for temperature monitoring
- Different terminal box positions and cable outlets
- With external ventilation for low speeds at high torque
- Integrated or supplied frequency converters
- Drives in accordance with CSA or NEMA

Of course, the installation of drives adapted specifically to your application is also possible. These are, for example:

- DC brush motors
- EC direct current drives
- Gear motors, adjustable or with fixed speed
- Air motors

Pump	Drive / Motor according to IEC frame size						
	56	63	71	80	90	100	112
2030-009	■		■				
2030-016	■		■				
2030-026	■		■				
3030-045		■	■				
3030-070		■	■				
3030-110		■	■				
4030-280			■	■			
4030-450			■	■			
4030-710			■	■			
5030-130				■	■	■	■
5030-210				■	■	■	■
5030-350				■	■	■	■

Additional equipment

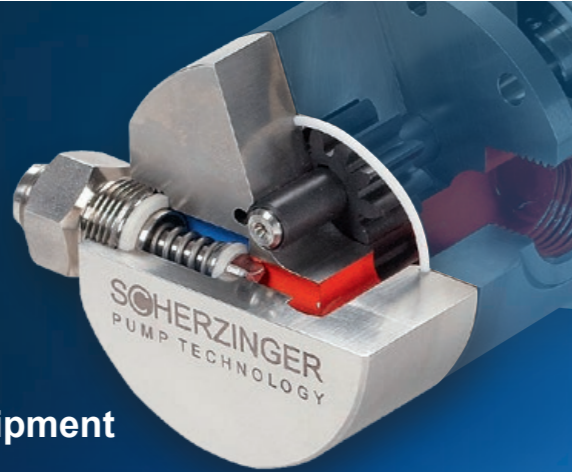

Valves

Our gear pumps are available in the basic version as feed pumps without valves.

This setup allows the pumping direction to be reversed in most applications.

Whether it is possible to reverse the pumping direction in your application case must be coordinated with Scherzinger. Optionally the pumps can be equipped with integrated valve technology.

B-Type: a pressure relief valve which can be adjusted from the outside is integrated here to protect the pump or the downstream system temporarily from overloading due to high pressure. The direction of rotation can be reversed to a limited extent.

R-Type: integrated pressure control valve used to regulate the pump outlet pressure to a preset pressure in continuous operation mode. If this version is used, a minimum amount of fluid must be discharged at the pump outlet, since the pump may otherwise overheat.

The application of integrated pressure relief or pressure control valves in explosion-proof areas is specified in detail in the overview table on page 15.

System integration

Besides supplying pure gear pumps and peripheral components, we also develop and design series system solutions for you.

For example, here is a photo of a dual-pump station for methanol dosing with a PLC control cabinet.

Line connections

Scherzinger Gear Pumps are distinguished by their great variability in terms of material combinations as well as the number of different piping installation options. For example, at least two different connection variants are available for every version.

All available standardized connection options for installation in your system are specified in the following table. Further connections are also available upon request.

Pumpe	BSP	NPT	SAE ISO 6162-2	ISO 1092-1 Form B, PN 40
2030	1/8 "	1/8 "	-	-
3030	1/4 "	3/8 "	-	DN 15
4030-280	1/2 "	3/4 "	-	DN 20
4030-450	1/2 "	3/4 "	-	DN 20
4030-710	3/4 "	1 "	-	DN 25
5030-130	1 "	1 1/4 "	DN 20	DN 20
5030-210	1 "	1 1/4 "	DN 25	DN 25
5030-350	1 1/2 "	1 1/2 "	DN 32	DN 32

Heating

We provide you with appropriate textile heating sleeves for the 3030 - 5055 series in order to pump fluids which cure at room temperature or pump at increased temperature. They can be used to compensate heat losses as well as heat the pumps after a system standstill.

The heating capacity is designed to allow the pump body to be heated at a standstill from an ambient temperature of 20°C up to a temperature of 100°C. Heating is performed electrically. The heating sleeve is equipped with a PT100 sensor for temperature monitoring.

It is connected to the additionally available control and regulation device with a supplied connection cable.

The maximum heating capacities of the sleeves for the respective pump sizes are:

- 60 W for 3030, 3040 and 3050
- 140 W for 4030, 4040 and 4050
- 350 W for 5030, 5040 and 5050



As a partner in concepts for application-specific Gear Pumps and conveying systems, Scherzinger provides you with comprehensive support for the fulfillment of your technical and logistic needs, from consultation up to the delivery of spare parts. Our global sales network enables us to respond with individual and flexible solutions to meet your requirements - reliably in good time.

Benefit from:

- Individual pump training courses tailored to your knowledge requirements.
- Uncomplicated and expert application consultation.
- Our wealth of experience in processing import, export and customs clearance.
- Short-term replacement deliveries within a few workdays.
- Professional repairs - your Gear Pump is returned to you in mint condition.

Application advice



Our wealth of experience and expertise in chemistry and process engineering enables us to give you advice tailored to your requirements.

An expert, highly efficient support and development team provides you with support already in the conception phase of your system.

Based on your specifications, we then design a Gear Pump solution which provides you with optimum reliability and safety in your application.

This offers important advantages in order to guide you to your goal in a more easily and quickly manner:

- Precise and quick tender preparation by means of sophisticated software and an extensive media database
- Tested pump concepts provide the basis for your optimum material combination.
- Extensive product documentation already during the tender preparation procedure

Tailor-made Gear Pump solutions

Do you also require maximum operational reliability in your application? We recognized this requirement at an early stage and have specialized on customized developments for over 80 years. We place a great emphasis on consistent quality orientation over the entire process chain.

Take the opportunity to engage in close cooperation with our product managers. It will provide you with prompt high-quality solutions tailored specifically to your application case - reliably and precisely.

Benefit from:

- A highly efficient and expert development team.
- The application of modern 3D CAD - CAM workstations.
- Quick and uncomplicated data exchange for all conventional CAD systems.
- Our core competence of processing very different materials.
- FMEA analysis tools for preventive fault identification.
- Quick application-specific adaption of series solutions by our development and prototype design departments.
- Diverse synergies from experiences gained in large-scale series production and customized productions.

Inspection and testing

The optimum, perfect quality of our products is very important to us. "Heart of Hightech" stands for reliability – which we can guarantee by means of detailed testing. Not only are new developments subjected to endurance tests in realistic operational conditions, each individual product is also tested for full functionality.

Our modern test field allows tests to be conducted according to your requirements:

- Several individual pump test stations
- Endurance test benches
- Climatic chambers for thermal tests
- Noise and pulsation measurements

www.scherzinger.de

Plant and Process Engineering

Automotive and Racing

Power Generation

Environmental Technology

Chemical and Petrochemical

Mechanical Engineering

Commercial Vehicles and Municipal
Technology

Building Technology

Medical Engineering

Pulp and Paper

 **SCHERZINGER**
PUMP TECHNOLOGY

**Scherzinger Pumpen
GmbH & Co. KG**

Bregstraße 23-25

78120 Furtwangen | Germany

Telephone +49 7723 6506-0

Fax +49 7723 6506-40

info@schertzinger.de

www.scherzinger.de